



# Preparation and characterization of sulfonated polysulfone and N-phthloyl chitosan blend composite cation-exchange membrane for desalination

Mahesh Padaki<sup>a</sup>, Arun M. Isloor<sup>a,\*</sup>, Pikul Wanichapichart<sup>b,c,\*\*</sup>, Ahmad Fauzi Ismail<sup>d</sup>

<sup>a</sup> Membrane Technology Laboratory, Chemistry Department, National Institute of Technology-Karnataka, Surathkal, Mangalore 575 025, India

<sup>b</sup> Membrane Science and Technology Research Center, Department of Physics, Prince of Songkla University, Hat Yai, Songkhla 90110, Thailand

<sup>c</sup> Thailand Center of Excellence in Physics, Commission on Higher Education, 328 Si Ayutthaya Road, Bangkok 10400, Thailand

<sup>d</sup> Advanced Membrane Technology Research Center (AMTEC), Universiti Teknologi Malaysia, 81310 Skudai, Johor Bahru, Malaysia

## ARTICLE INFO

### Article history:

Received 22 February 2012

Received in revised form 14 April 2012

Accepted 25 April 2012

Available online 2 June 2012

### Keywords:

Sulfonation

N-phthloyl chitosan

Ion-exchange capacity

Diffusion potential

## ABSTRACT

Sulfonated polysulfone (sPSF) was prepared and used as a polymer matrix for cation-exchange membranes (CEM). The sulfonation reaction was carried out at room temperature and the degree of sulfonation was calculated by titration method. Blend composite membranes were prepared using different ratios of sPSF and modified chitosan (CS). Membrane properties were studied in terms of water flux, water swelling ratio, molecular weight cut off (MWCO), ion-exchange capacity (IEC) and contact angle measurement. Charge on the membrane was confirmed by ionic diffusion potential (DP). It was observed that, DP increased with the increase in the concentration of sPSF. The membrane sPSF:CS 60:40 showed 1000 Da MWCO, 14.6 mV diffusion potential (DP) and 0.083 mM/g of IEC. Similarly sPSF:CS 90:10 showed 10,000 Da MWCO, 71.7 mV diffusion potential (DP) and 0.176 mM/g of IEC. Moreover, membrane sPSF:CS 60:40 showed 93%, 89% and 69% for MgSO<sub>4</sub>, Na<sub>2</sub>SO<sub>4</sub> and NaCl rejection respectively.

© 2012 Elsevier B.V. All rights reserved.

## 1. Introduction

A large number of ion-exchange membranes have been widely studied due to their versatile applications in food, drug and chemical industries, waste water treatment, and separation processes [1–6]. Ion-exchange membranes have also been used in electrodialysis of brackish water desalination for several decades. For the desalination application, it is essential for ion-exchange membranes to possess high selectivity and productivity. To date, most of the ion-exchange membrane studies have been focused on Nafion, sulfonated polystyrene and sulfonated poly (phenylene oxide) based material systems. Lau and Ismail in 2009, studied the effect of sulfonated polysulfone on nanofiltration membrane [7]. Bolong et al. [8] in 2010, reported that, charged membranes are more effective in removal of bisphenols from waste water. On the other hand, polysulfone is apparently the best material that can be used for the fabrication of membranes for pressure-driven processes [9]. This is due to its reasonable price, its good film forming ability and its thermal, mechanical and chemical resistances. Chemical modification of polysulfone such as sulfonation and carboxylation has created more interest in ion-exchange

membranes [10,11]. However, the polysulfone and modified polysulfone membranes, made by phase inversion are mainly good for ultrafiltration, i.e. their selectivity to small dissolved organic molecules and salts is very limited. This limitation was stimulated by blending compositions with polymeric material [12].

Chitosan is a very useful polymer in membrane technology because of its reasonable hydrophilicity. Chitosan is a natural and environmentally friendly material. Membranes prepared from chitosan have been developed for solution filtering, which improved the qualities of feed solution and these can be used in separation techniques such as ultrafiltration and reverse osmosis [13,14]. Previous researchers [15] have reported that, the lesser hydrophilic property of chitosan often leads to problems in performance such as mechanical strength. To enhance the performance of chitosan membranes, chemical modification was utilized to modify the chitosan properties for preparing composite membranes with better hydrophilicity, surface charge and biological compatibility [15]. The structural modification of the chitosan enhances its solubility. Despite their contrasting characteristics, polysulfone and chitosan are the good candidates for the proper blend composite membranes [16]. Modified chitosan provides better hydrophilicity and polysulfone could ensure structural stability of the composite blend [17]. Due to considerable difference in the chemical structure, solubility of these two polymers is unlikely. In order to improve the solubility of chitosan, chemical modification is currently suggested.

In our recent work [17], N-phthloyl chitosan was synthesized by reacting chitosan with phthalic anhydride in di-methylformamide.

\* Corresponding author. Fax: +91 824 2474033.

\*\* Correspondence to: P. Wanichapichart, Membrane Science and Technology Research Center, Department of Physics, Prince of Songkla University, Hat Yai, Songkhla 90110, Thailand.

E-mail addresses: [isloor@yahoo.com](mailto:isloor@yahoo.com) (A.M. Isloor), [pikul.v@psu.ac.th](mailto:pikul.v@psu.ac.th) (P. Wanichapichart).

The polysulfone and N-phthaloyl chitosan in different compositions were used to prepare blend composite (PSf/CS) novel membranes. N-phthaloyl chitosan has showed more effect on pore size. Concentration of N-phthaloyl chitosan increases the hydrophilicity of the membrane. Sulfonated polysulfone is a useful material in membrane technology [7]. SO<sub>3</sub>H group from the sulfonated polysulfone creates the charge on the membrane surface which induces the Donnan's effect. Hence, N-phthaloylchitosan and sulfonated polysulfones were selected as a membrane material.

We have carried out sulfonation of the polysulfone to introduce negative charge on membranes, with the hope of enhancing the efficiency. The resulting sulfonated polysulfone (sPSf) was used for fabrication of composite ion-exchange membranes with N-phthaloyl chitosan (CS). The chemical and physical properties of the prepared membranes, such as: water flux, swelling ratio, ion-exchange capacity, diffusion potential, MWCO, and salt rejection of NaCl, Na<sub>2</sub>SO<sub>4</sub> and MgSO<sub>4</sub> solutions were studied.

## 2. Materials and methods

### 2.1. Preparation of sulfonated polysulfone

Polysulfone (PSf) (MW 35000 Da, Sigma Aldrich) was sulfonated according to the procedure described by Chao et al. [18]. Dried PSf of 10 g was dissolved in 100 mL of anhydrous 1,2-dichloroethane in a 250 mL two-neck round bottom flask equipped with a condenser and nitrogen purge inlet. The synthetic path has been presented in Scheme 1. The resulting solution was purged with nitrogen for 1 h and 2.6 mL of chlorosulfonic acid diluted in 20 mL 1,2-dichloroethane was added drop wise during a period of 30 min. The amount of intermediate product depends on the mole ratio of sulfonating agent and polymer-repeating units. The resulting solution was vigorously stirred for 12 h at 30 °C. After the completion of the reaction, sPSf was isolated from the solution by precipitation with methanol, and then the polymer was washed with deionized water for several times and dried at 60 °C under vacuum to attain constant weight. The FT-IR spectrum of sPSf was recorded as KBr pellets in the range of 4000–400 cm<sup>-1</sup>. Degree of sulfonation was determined by titration method as described in literature [19]. It was found to be 49%.

### 2.2. Preparation of N-phthaloyl chitosan

Chitosan modification was done according to the procedure reported by Ohya et al. [20]. In brief, 23.7 g chitosan (MW 5.4 × 10<sup>5</sup>, 91% degree of deacetylation) reacted with 64.5 g phthalic-anhydride in 100 mL di-methylformamide (DMF) at 130 °C for 5 h, under nitrogen atmosphere. The reaction mixture was poured into a large amount of ice-cold water to precipitate N-phthaloyl chitosan. It was,

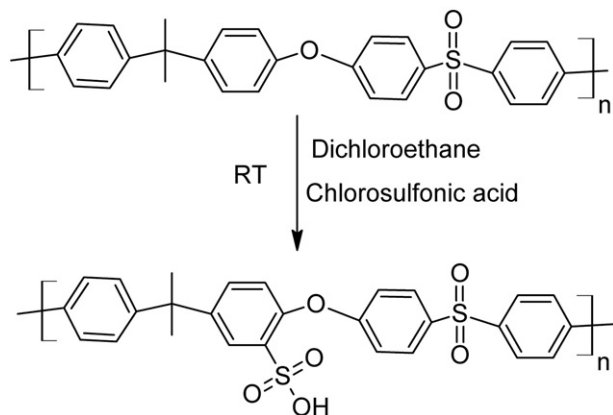

Scheme 1. Schematic representation of sulfonation of polysulfone.

then, filtered and purified by ethanol and ethyl ether to obtain yellow solid with 80.6% yield. Scheme 2 represents the preparation of N-phthaloyl chitosan.

### 2.3. Preparation of composite membranes

sPSf:CS composite blend membranes were prepared by phase inversion method [21]. Several ratios of sPSf and N-phthaloyl chitosan were dissolved in N-methyl pyrrolidone (NMP) at 60 °C for 24 h on a hot plate and stirred until a viscous and clear solution was obtained. The solution was filtered by G4 sand filter immediately. The solution was cast on the glass plate using glass rod. The thickness of the wet membrane was maintained at 0.2 mm. It was, then, evaporated at room temperature for 30 s, and immersed in a coagulation water bath at room temperature for 30 min, after which the membrane was separated from the glass plate, washed with distilled water and stored in distilled water until use.

### 2.4. Characterization of the membrane

The FT-IR and ATR-IR spectra of polymers and membranes were measured using spectrophotometer (Avatar 360 FT-IR). Before recording the spectrum, the membrane was dried in a desiccator for 24 h. DSC thermogram of membranes was recorded on a Perkin-Elmer instrument (Pyris 1) at a heating rate of 10 °C min<sup>-1</sup>. Scans were carried out from 30 °C to 300 °C under the presence of atmospheric oxygen.

### 2.5. Ion-exchange capacity (IEC)

IEC indicates the number of millimoles of ions in 1 g of the dry membrane. The IEC of the membrane was measured by a conventional titration method. The membrane in H<sup>+</sup> form was immersed in a 2 M NaCl solution for 24 h for the complete replacement of H<sup>+</sup> with Na<sup>+</sup>. The remaining solution was then titrated with 0.01 M of NaOH using phenolphthalein indicator. The IEC value was calculated by following equation.

$$\text{IEC}(\text{mmol/g}) = \left( \frac{0.01 \times 1000 \times V}{W_d} \right) \quad (1)$$

where  $V$  (L) is the volume of NaOH solution consumed by the titration and  $W_d$  (g) is the weight of the dry membrane sample. The titration was carried out with an accuracy of 0.001 mM/g [22].

### 2.6. Membrane diffusion potential

As reported by Wanichapichart and Yu [23], the membrane potential ( $\Delta\Psi$ ) of the sPSf:CS was measured in a two compartment cell as shown in Fig. 1, chamber I and chamber II, in which a vertical membrane of 2.0 cm<sup>2</sup> effective area separated two KCl solutions of different concentrations, the chamber I having a 100 mM and chamber II a 0.1 mM KCl solution. Diffusion potential difference across the membrane was measured using a voltmeter which was connected to a calomel reference electrode. This study explores the ionic permeability ratio using the Goldman equation, as described in [24]

$$\Delta\Psi = -\frac{RT}{nF} \left[ \ln \frac{C_k^1 + \beta C_{Cl}^2}{C_k^2 + \beta C_{Cl}^1} \right] \quad (2)$$

where  $\beta$ , ionic permeability ratio,  $R$ ,  $T$ , and  $F$  are molar gas constant, temperature in Kelvin and Faraday constant,  $C_k^1$  concentration of K<sup>+</sup> ions in solution 1,  $C_k^2$  concentration of K<sup>+</sup> ions in solution 2,  $C_{Cl}^1$  concentration of Cl<sup>-</sup> ions in solution 1 and  $C_{Cl}^2$  concentration of Cl<sup>-</sup> ions in solution 2 respectively.

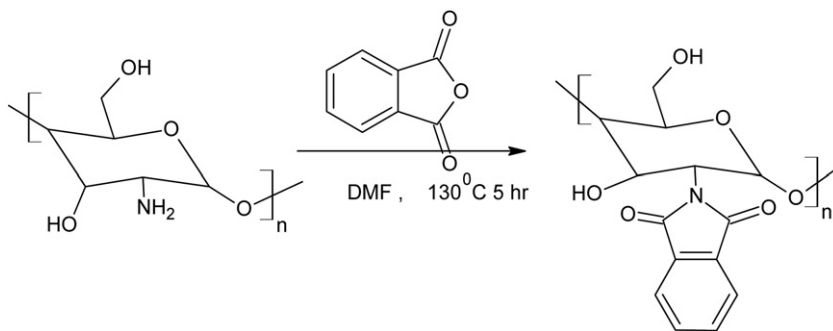

Scheme 2. Schematic representation of the prepared N-phthloyl chitosan.

### 2.7. Water swelling behavior and contact angle

Swelling behavior of the prepared membrane was determined by weight change during swelling in distilled water. Membranes were thoroughly rinsed with distilled water, and then dried in vacuum desiccators with a vacuum of 120 mm Hg for 24 h. The dried membrane was made in 1 cm<sup>2</sup> small pieces and later immersed in distilled water. The membranes were taken out every 1 h interval of time, and excess water on the surface was gently removed by a blotter. Then the weight of the swollen membranes was quickly measured. Degree of swelling was calculated using the following formula.

$$\% \text{swelling} = \left( \frac{W_w - W_d}{W_d} \right) \times 100 \quad (3)$$

where  $W_w$  and  $W_d$  are the weights of swollen and dried membranes respectively [25]. Water swelling in different pH was also carried out to study the chemical stability of membranes in different pH.

The contact angle between water and the membrane surface was measured with a FTA-200 Dynamic contact angle measurement according to the sessile droplet method. Briefly, a water droplet was deposited on a flat homogenous membrane surface and the contact angle of the droplet with surface was measured. Each contact angle was measured five times at different points of each membrane sample and the average value was reported.

### 2.8. Performance of the membrane

All the permeation experiments were performed at room temperature using dead end desalination cell [26]. A circular membrane sample with diameter of 60 mm was placed in the test cell with the active surface facing towards the incoming feed. Effective membrane

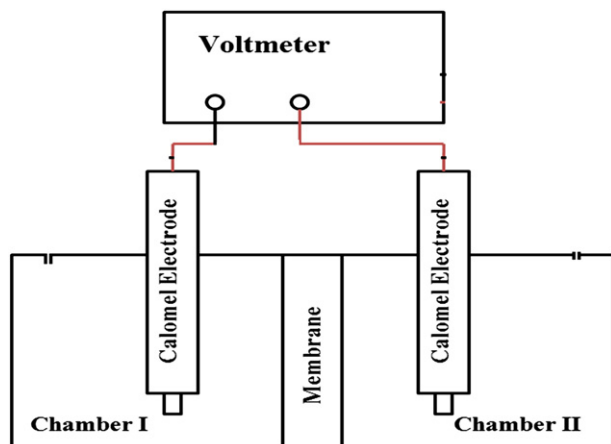

Fig. 1. Diffusion potential cell.

diameter was 50 mm. The flux was measured by direct measurement of the permeate flow in terms of Lm<sup>-2</sup> h<sup>-1</sup>. The molecular weight cut off was studied using different molecular weights of PEG solutions. The concentrations of PEG solutions were determined by using a spectrophotometer. Salt rejection experiment was done using 1000 ppm of NaCl, Na<sub>2</sub>SO<sub>4</sub> and MgSO<sub>4</sub>. The percent salt rejection was determined by comparing the concentration of feed and permeate solutions. Concentration was measured by measuring the conductivity. From the results, the percent retention was calculated using the following formula.

$$\%R = \left( 1 - \frac{C_p}{C_f} \right) \times 100 \quad (4)$$

where  $C_p$  is the salt concentration in permeate and  $C_f$  the concentration in the feed. The same 1000 ppm concentration of NaCl, Na<sub>2</sub>SO<sub>4</sub>, and MgSO<sub>4</sub> solution was used as feed. Using the same method, the effect of pressure on flux and percent rejection was studied.

## 3. Result and discussion

FT-IR spectra of N-phthloyl chitosan and sulfonated polysulfone were measured for confirmation of the product by KBr pellet method. Fig. 2A shows the peaks of N-phthloyl chitosan at 3447 cm<sup>-1</sup> for the OH group, 1703 cm<sup>-1</sup> for the imide C=O, 1381 cm<sup>-1</sup> for the C–N group, 1058 cm<sup>-1</sup> for the C–OH group and 714 cm<sup>-1</sup> for the aromatic C=C group. Fig. 2B shows the FT-IR spectrum of sPSf. Strong characteristic peaks at 1010 and 1097 cm<sup>-1</sup> were observed in the sulfonated polymers, corresponding to symmetric and asymmetric stretching of the sulfonate group respectively. The presence of strong peak at 1241 cm<sup>-1</sup> to 1243 cm<sup>-1</sup> is assigned to the ether C–O–C stretch of the polysulfone moiety and the peak at 1169 cm<sup>-1</sup> to 1170 cm<sup>-1</sup> due to O=S=O stretching. Aromatic C–H bond could be detected at 1141 cm<sup>-1</sup>. Fig. 2C shows the ATR-IR spectra of the membranes.

The thermal behaviors of different blend membranes were studied from the DSC plots. DSC was recorded at a heating rate of 10 °C min<sup>-1</sup>. Scans were carried out from room temperature to 300 °C in the absence of atmospheric oxygen. Fig. 3 shows the DSC graphs of membranes. From the thermal study, it was clear that, the blend membranes showed a single  $T_g$  value. This confirms the formation of a blend, as a result of many Van der Waals interactions between two polymers.

### 3.1. IEC, water swelling and contact angle measurements

In the present work, PSf was sulfonated by chlorosulfonic acid at room temperature in order to introduce negative charge groups onto the polymer chains. The ion-exchange capacity (IEC) provides information on the charge density in the membranes, which is an important factor related to the conductivity and transport properties of

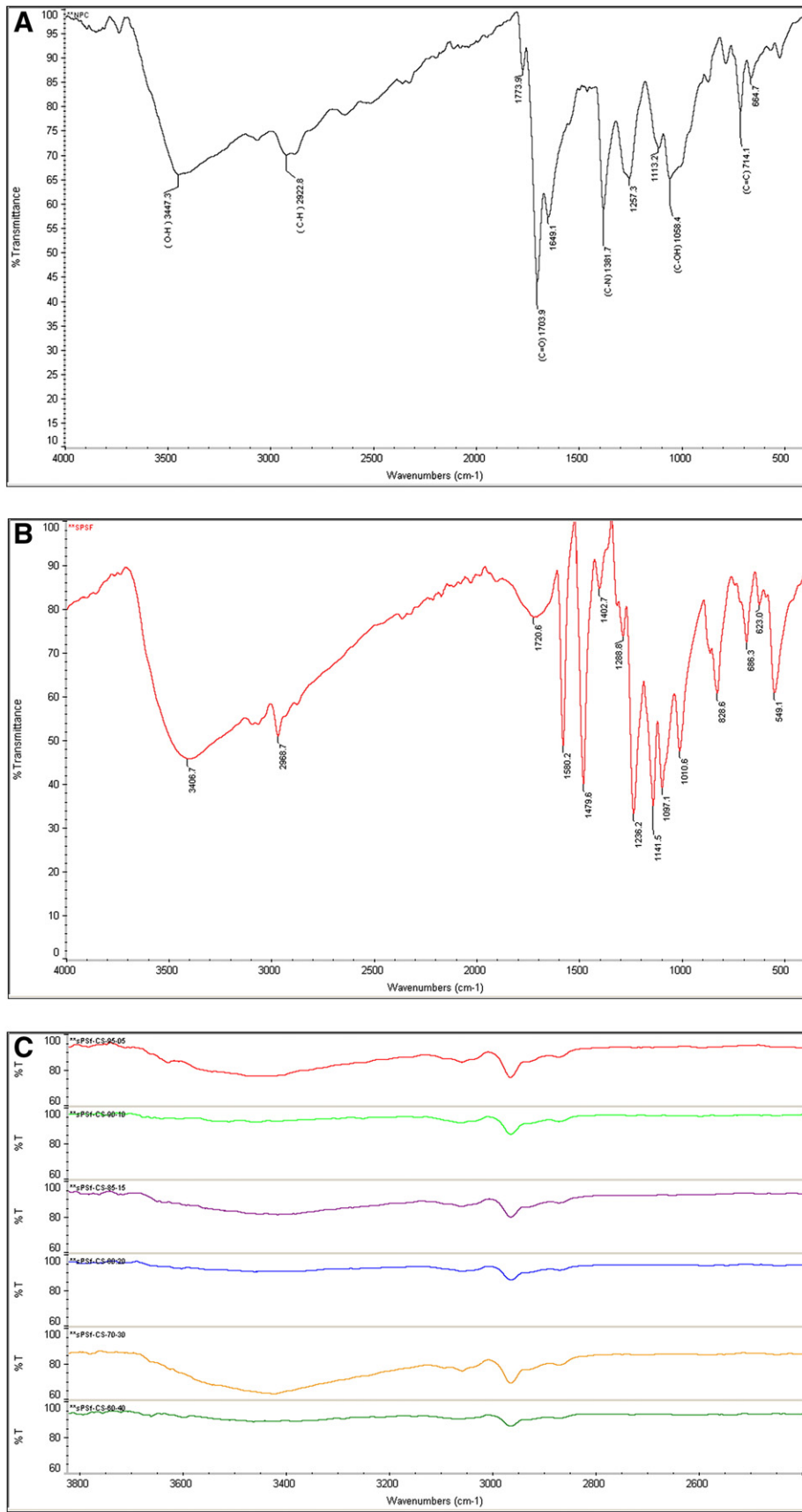

Fig. 2. A: FT-IR spectrum of the N-phthloyl chitosan. B: FT-IR spectrum of the sulfonated polysulfone. C: ATR-IR spectra of the membranes.

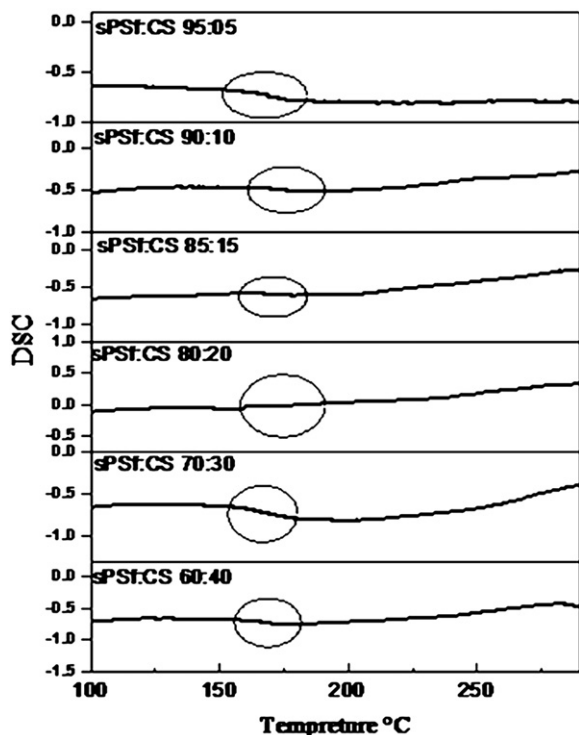

Fig. 3. DSC of the membranes.

the membranes. The ion-exchange capacity, hydraulic permeability and contact angles of the membranes are summarized in Table 1. The IEC and hydraulic permeability coefficient increased with the increase in the concentration of the composition of the sPSf due to the presence of more hydrophilic sulfonic acid groups in the polymer matrix. This is consistent with the increase of water swelling of the membranes with higher concentration composition of the sPSf, indicating higher hydrophilicity. Further it was also confirmed by contact angle measurement. Contact angle decreased with the increase of the concentration of sPSf. Water swelling test was done with different intervals of time. Fig. 4A shows % water swelling in different intervals of time. It was clear that after 12 h, the membrane showed the same % of water swelling. Water swelling test was also done under different pH. Fig. 4B shows the % water swelling under different pH values. The chemical stability of the membrane at different pH can be explained by water swelling study of membranes under different pH. Membranes showed more water swelling in basic pH, as sodium ion present in the solution exchanged with hydrogen ion of the sulfonic acid group. However, under strong acidic condition, membrane was unstable due to the formation of larger pores, which resulted in more water swelling of the membrane.

### 3.2. Diffusion potential of the sPSf:CS blend composite membrane

As shown in Table 2, the membrane sPSf:CS 90:10 showed the highest diffusion potential and membrane sPSf:CS 60:40 showed the

Table 1  
Physical properties of the membranes.

Membrane	IEC (mM/g)	Hydraulic permeability coefficient m/sPa	Contact angle °
sPSf:CS60:40	0.083	$3.51 \times 10^{-12}$	$87.48 \pm 2$
sPSf:CS70:30	0.136	$6.08 \times 10^{-12}$	$83.01 \pm 2$
sPSf:CS80:20	0.169	$9.41 \times 10^{-12}$	$82.32 \pm 2$
sPSf:CS85:15	0.175	$3.14 \times 10^{-11}$	$78.36 \pm 2$
sPSf:CS90:10	0.176	$4.86 \times 10^{-11}$	$78 \pm 2$
sPSf:CS95:05	0.177	$8.86 \times 10^{-11}$	$76.63 \pm 2$

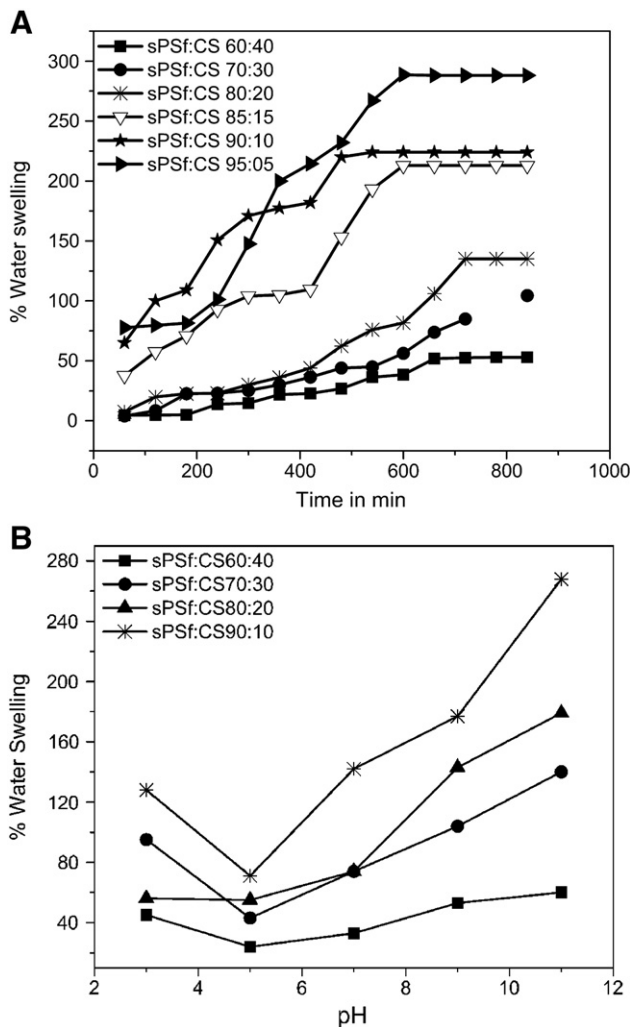

Fig. 4. A: Percentage of water swelling against time intervals. B: Percentage of water swelling against pH.

lowest diffusion potential. Membrane diffusion potential is affected by sulfonation of polysulfone and tends to increase with the sPSf composition concentration. In the case of sPSf:CS 95:05, diffusion potential is less, it may be because of larger pore size. Table 2 represents the diffusion potential, which increases in relation with the sPSf concentration. The diffusion potential is derived from the Nernst-Planck equation, which includes both electrical and diffusion terms. Table 2 represents the diffusion potential as well as  $\beta$  values. A positive potential in chamber II compared to chamber I was obtained in all cases. The negative sign implied that  $K^+$  moves from membrane surface I to membrane surface II faster than  $Cl^-$ . Further study was done by replacing chamber I and chamber II with a mixture of KCl solution under different concentration ratios. In this experiment, the membrane surface II experienced equal ratio of the two salts as in chamber I but much lower in concentration. Calculation of  $\beta$  was done using Eq. (2). The experimental data revealed the values as shown in Table 2.

### 3.3. Performance of the membrane

Membranes based on sPSf:CS blend membranes were prepared in different compositions and the maximum possible composition was found to be 60:40. The water flux of membranes is an essential parameter, which is useful for any industrial process. Water flux was influenced by the composition of the membrane material [27].



**Table 2**  
Diffusion potential of the sPSf:CS blend composite membrane.

Membrane	Diffusion potential in mV	$\beta$
sPSf:CS 60:40	14.6	0.27
sPSf:CS 70:30	42.43	0.74
sPSf:CS 80:20	53.06	0.83
sPSf:CS 85:15	53.36	0.84
sPSf:CS 90:10	71.7	0.97
sPSf:CS 95:05	31.3	0.61

Water flux of the membrane was studied using dead end flow cell in different pressures ranging between 200 kPa and 800 kPa. Fig. 5 shows the water permeation results.

It is evident from the study that, increase of pressure, linearly increased the water permeation. Water permeability coefficient of the membrane was calculated using the slope and tabulated in Table 2. According to the Spiegler–Kedem model [25], the membrane pore size can be confirmed by water permeability coefficient values. In the present study, water permeability coefficient increased with the increase in the composition of sPSf. The membrane sPSf:CS 95:05 which showed highest water flux indicated that, the membrane is having larger pore sizes. It was confirmed by small diffusion potential since it could not effectively select for salt rejection.

The MWCO values are shown in Fig. 6. The MWCO was determined for pore size of the blend membranes. The membrane with 60:40 composition showed 1000 Da cut off value. It was observed that, increase in the composition of sulfonated polysulfone, decreases the MWCO. From the water flux and water swelling study, it was confirmed that, membrane pore area was increased with the increase in composition of sulfonated polysulfone. Membrane sPSf:CS 90:10 showed MWCO greater than 10,000 Da, which was too large to be used for salt rejection.

In desalination, nanofiltration membranes are preferred over reverse osmosis, as relatively high flux can be obtained with reasonable rejection of solute at comparatively less operating pressure. Performance study was done by using 1000 ppm of NaCl, Na<sub>2</sub>SO<sub>4</sub> and MgSO<sub>4</sub> solutions. Salt rejection of the membranes has been presented in Fig. 7(A–C). It was interesting to observe that, there was a tendency of a decline in salt rejection under higher applied pressures in all cases. It might be due to increase in the pore size at higher pressure. It was confirmed from the study of water flux of the same membrane used for rejection test. Membrane permeation was observed without any pressure. From the rejection study, it was clear that, rejection was

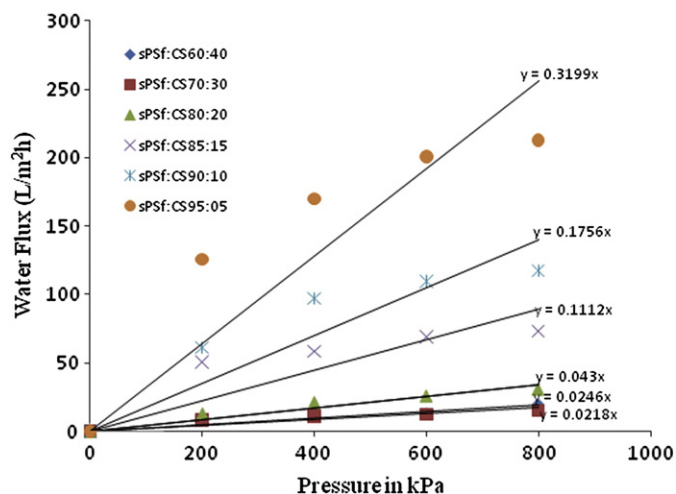

Fig. 5. Water flux study in different pressures.

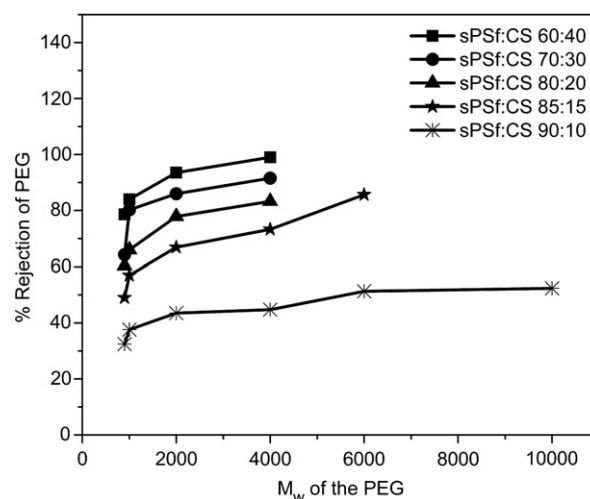

Fig. 6. Membrane rejection of known PEG molecular weight.

decreased in the order of MgSO<sub>4</sub>, Na<sub>2</sub>SO<sub>4</sub> and NaCl as shown in Fig. 7(A–C). Higher rejection of MgSO<sub>4</sub> over NaCl can be explained using size exclusion and Donnan exclusion principle, as MgSO<sub>4</sub> is larger in size than that of NaCl, so it showed greater rejection. Donnan exclusion is less effective in bulk concentration of solute. This is because, at higher concentration, the time taken by the solute to reach the membrane surface is faster [28]. The membranes are having negatively charged sulfonic groups, which have strong tendency to make a complex with divalent cations. It is believed that with increase in ionic strength, the tendency of magnesium ions to reach membrane surface increases and as a result of which the rejection of magnesium ions decreased with hardly any change in the rejection of monovalent sodium ions [28].

The membrane sPSf:CS 60:40 showed the greatest rejection for MgSO<sub>4</sub> at about 92%, and that for Na<sub>2</sub>SO<sub>4</sub> and NaCl are at 86.11% and 66%, respectively. The sPSf:CS 90:10 showed the smallest rejection for MgSO<sub>4</sub>, Na<sub>2</sub>SO<sub>4</sub> and NaCl at about 34.1%, 26.6% and 7.6%, respectively. These results confirmed that, the membrane sPSf:CS 60:40 possessed the smallest pore size, compared to the others.

#### 4. Conclusions

The forgoing discussion concludes that sPSf:CS blend composite membranes are cation-exchange membranes for desalination. Membrane diffusion potential and IEC of the membrane confirmed that, the prepared membrane has negative charge. Hydrophilicity and membrane charge are greatly affected by sulfonation of polysulfone and tend to increase with the sPSf concentration, which was confirmed by water swelling test and contact angle measurement. In the MWCO study, the membrane with 60:40 composition showed 1000 Da of MWCO. And it has been observed that, increase in the concentration of sulfonated polysulfone, decreases the MWCO. Using these statistics, it was concluded that the composition concentration of sulfonated polysulfone affects the performance of the membrane.

#### Acknowledgement

AMI thank the Department of Atomic energy, Board of Research in Nuclear Sciences, Govt. of India for the young scientist award. The authors also thank Vision Group for Science & Technology, Government of Karnataka, India for the 'Best paper award'. MP thanks NITK Surathkal, India and PSU Hat Yai, Thailand for supporting this collaborative research.

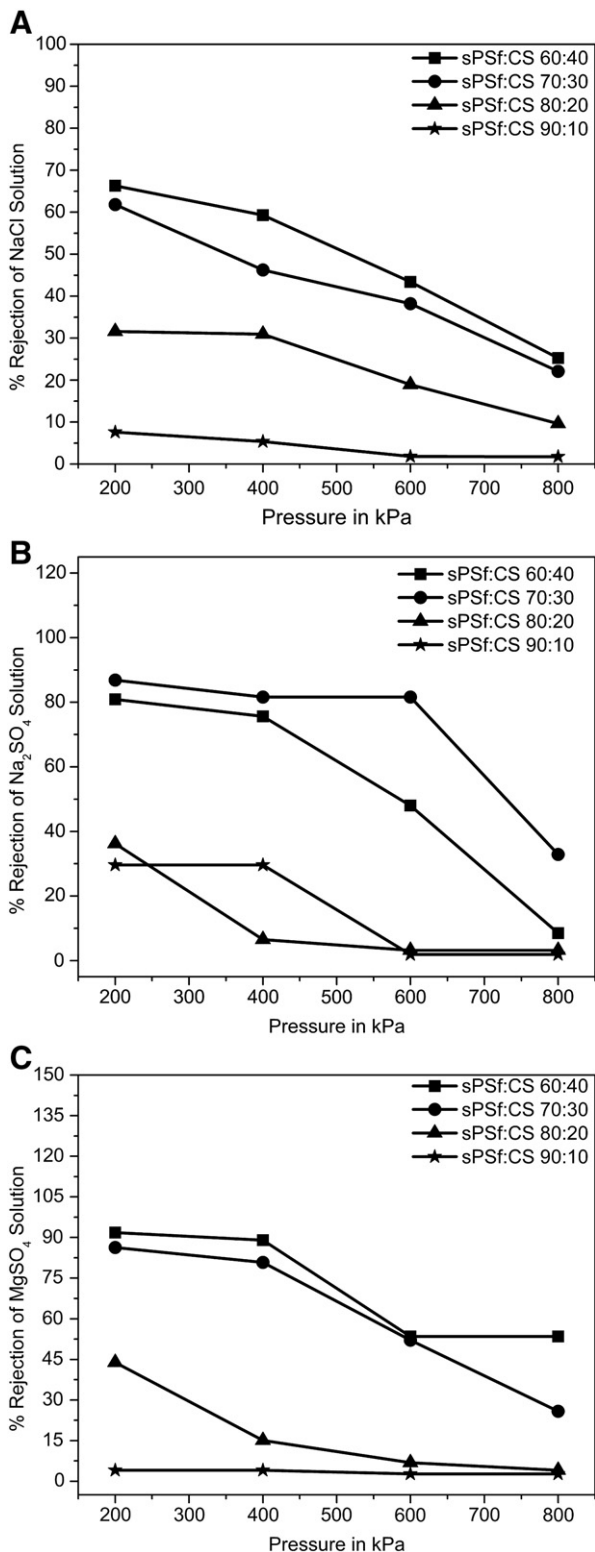

Fig. 7. A: Rejection study of the NaCl solution. B: Rejection study of the Na<sub>2</sub>SO<sub>4</sub> solution. C: Rejection study of the MgSO<sub>4</sub> solution.

## References

[1] G.S. Gohil, R.K. Nagarale, V.V. Binsu, V.K. Shahi, Preparation and characterization of monovalent cation selective sulfonated poly (ether ether ketone) and poly (ether sulfone) composite membranes, *J. Colloid Interface Sci.* 298 (2006) 845–853.

[2] J. Balster, O. Krupenko, I. Punt, D.F. Stamatialis, M. Wessling, Preparation and characterization of monovalent ion selective cation exchange membranes based on sulfonated poly (ether ether ketone), *J. Membr. Sci.* 263 (2005) 137–145.

[3] R. Scherer, A.M. Bernardes, M.M.C. Forte, J.Z. Ferreira, C.A. Ferreira, Preparation and physical characterization of a sulfonated poly (styrene-co-divinylbenzene) and polypyrrole composite membrane, *Mater. Chem. Phys.* 71 (2001) 131–136.

[4] M.S. Kang, Y.J. Choi, I.J. Choi, T.H. Yoon, S.H. Moon, Electrochemical characterization of sulfonated poly (arylene ether sulfone) (S-PES) cation-exchange membranes, *J. Membr. Sci.* 216 (2003) 39–53.

[5] A. Elattar, N. Elmidaoui, N. Pismenskaia, C. Gavach, G. Pourcelly, Comparison of transport properties of monovalent anions through anion-exchange membranes, *J. Membr. Sci.* 143 (1998) 249–261.

[6] W. Richard Bowen, A. Wahab Mohammad, H. Nidal, Characterisation of nanofiltration membranes for predictive purposes – use of salts, uncharged solutes and atomic force microscopy, *J. Membr. Sci.* 126 (1997) 91–105.

[7] W. Lau, A.F. Ismail, Effect of SPEEK content on the morphological and electrical properties of PES/SPEEK blend nanofiltration membranes, *Desalination* 249 (2009) 996–1005.

[8] N. Bolong, A.F. Ismail, M.R. Salim, D. Rana, T. Matsuura, A. Tabe-Mohammadi, Negatively charged polyethersulfone hollow fiber nanofiltration membrane for the removal of bisphenol A from wastewater, *Sep. Purif. Technol.* 73 (2010) 92–99.

[9] E. Drioli, L. Giorno, *Membrane Operations*, Wiley-VCH Verlag GmbH & Co. KGaA, 2009.

[10] F. Lufano, I. Gatto, P. Staiti, V. Antonucci, E. Passalacqua, Sulfonated polysulfone ionomer membranes for fuel cells, *Solid State Ionics* 145 (2001) 47–51.

[11] C.J. Sajitha, R. Mahendran, D. Mohan, Studies on cellulose acetate-carboxylated polysulfone blend ultrafiltration membranes—part I, *Eur. Polym. J.* 38 (2002) 2507–2511.

[12] J. Miao, G. Chen, C. Gao, C. Lin, D. Wang, M. Sun, Preparation and characterization of N, O carboxymethylchitosan (NOCC)/polysulfone (PS) composite nanofiltration membranes, *J. Membr. Sci.* 280 (2006) 478–484.

[13] D.A. Musale, S.S. Kulkarni, Fouling reduction in poly (acrylonitrile-co-acrylamide) ultrafiltration membranes, *J. Membr. Sci.* 111 (1996) 49–56.

[14] T. Yang, R.R. Zall, Chitosan membrane for reverse osmosis application, *J. Food Sci.* 49 (1984) 91–93.

[15] N. Yuana, R. Tsai, M. Hob, D. Wang, J. Laic, H. Hsieh, Fabrication and characterization of chondroitin sulfate-modified chitosan membranes for biomedical applications, *Desalination* 234 (2008) 166–174.

[16] W. Ying, Katherine A.M. Creber, P. Brant, V. Tambui, Chitosan-based electrolyte composite membranes: II. Mechanical properties and ionic conductivity, *J. Membr. Sci.* 284 (2006) 331–338.

[17] M. Padaki, A. Isloor, P. Wanichapichart, Polysulfone/ N-phthloyl chitosan novel composite membranes for salt rejection application, *Desalination* 279 (2011) 409–414.

[18] H.S. Chao, D.R. Eley, Process for preparing sulfonated poly (arylether)resins. US patent number 4,625,000; 1986.

[19] K. Chalida, P. Bradley, G.Q. Ladewiga, L. Max, W. Lianzhou, Preparation and characterization of sulfonated polyethersulfone for cation-exchange membranes, *J. Membr. Sci.* 368 (2011) 48–53.

[20] Y. Ohya, S. Marushashi, K. Shizuno, S. Mano, J. Murata, T. Uchi, Graft polymerization of styrene on chitosan and the characteristics of the polymer, *J. Macromol. Sci. Part A* 36 (1999) 339–353.

[21] C. Hegde, A.M. Isloor, M. Padaki, P. Wanichapichart, Y. Liangdeng, Synthesis and desalination performance of Ar<sup>+</sup>-N<sup>+</sup> irradiated polysulfone based new NF membrane, *Desalination* 265 (2011) 153–158.

[22] M. Padaki, A.M. Isloor, G. Belavadi, N. Prabhu, Preparation, characterization and performance study of poly(isobutylene-alt-maleic anhydride) [PIAM] and polysulfone[PSf] composite membranes before and after alkali treatment, *Ind. Eng. Chem. Res.* 50 (2011) 6528–6534.

[23] P. Wanichapichart, L. Yu, Chitosan membrane filtering characteristics modification by N-ionbeams, *Surf. Coat. Technol.* (2007) 2018165–2018169.

[24] D.E. Goldman, *J. Gen. Physiol.* 27 (1943) 37–60.

[25] M. Padaki, A. Isloor, K. Nagaraja, H. Nagaraja, M. Pattabi, Conversion of microfiltration membrane into nanofiltration membrane by vapour phase deposition of aluminium for desalination, *Desalination* 274 (2011) 177–181.

[26] Y.Z. Xu, R.E. Lebrun, Comparison of nanofiltration properties of two membranes using electrolyte and nonelectrolyte, *Desalination* 122 (1999) 95–106.

[27] R. Mahendran, R. Malaisamy, D. Mohan, Preparation, characterization and effect of annealing on performance of cellulose acetate/sulfonated polysulfone and cellulose acetate/epoxy resin blend ultrafiltration membranes, *Eur. Polym. J.* 40 (2004) 623–630.

[28] N. Dipankar, T. Kuo-Lun, H. Chi-Chung, C. Ching-Jung, R. Ruoh-Chyu, C. Yan-Che, C. Chih-Shen, W. Tien-Hwa, Effect of solution chemistry on water softening using charged nanofiltration membranes, *Desalination* 234 (2008) 344–353.